

**RING RAISED FACE**

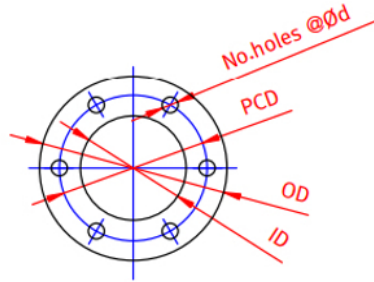

**FULL FACE**

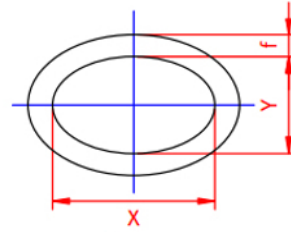

**OVAL, MANHOLE, HANDHOLE**

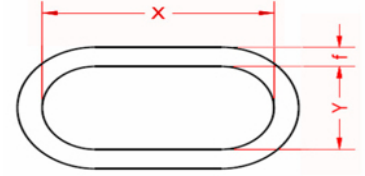

**OBROUND**

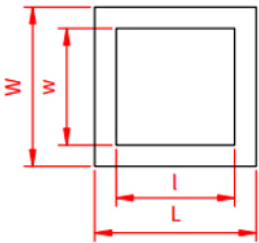

**SQUARE**

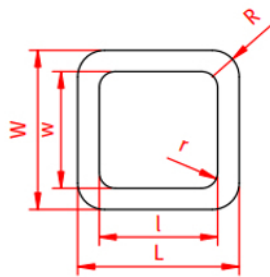

**SQUARE RADIUS CORNERS**

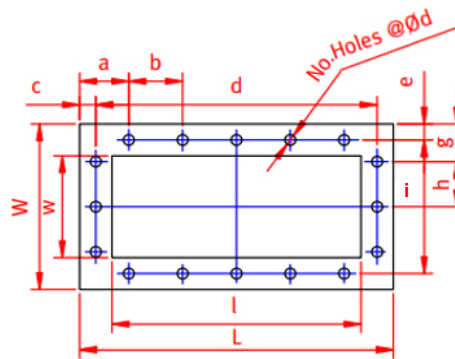

**RECTANGULAR**

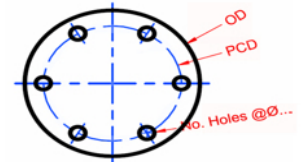

**BLIND**

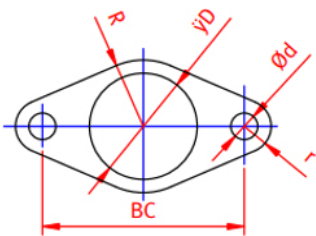

**TWO BOLT FLANGE**

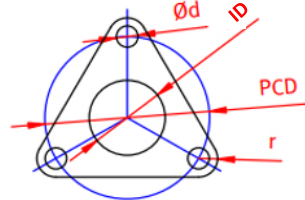

**THREE BOLT FLANGE**

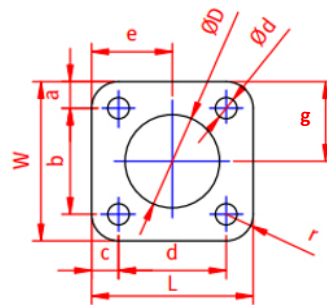

**FOUR BOLT FLANGE**

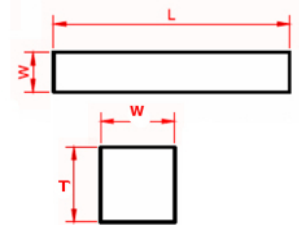

**STRIP**

**Measurements (in millimeters)**

<b>OD:</b> Outside Diameter		<b>R/r:</b> Radius	
<b>ID:</b> Inside Diameter		<b>X:</b> x axis Dimension	
<b>PCD:</b> Pitch Circle Diameter		<b>Y:</b> y axis Dimension	
<b>n:</b> Number of holes		<b>f:</b> Flange Width	
<b>Ød:</b> Hole Diameter		<b>T:</b> Thickness	
<b>L/l:</b> Length		<b>Q:</b> Quantity	
<b>W/w:</b> Width		<b>Material Type</b>	
<b>a, b,...w:</b> Spec. Dimension			

# GASKET MEASUREMENT SPECIFIER

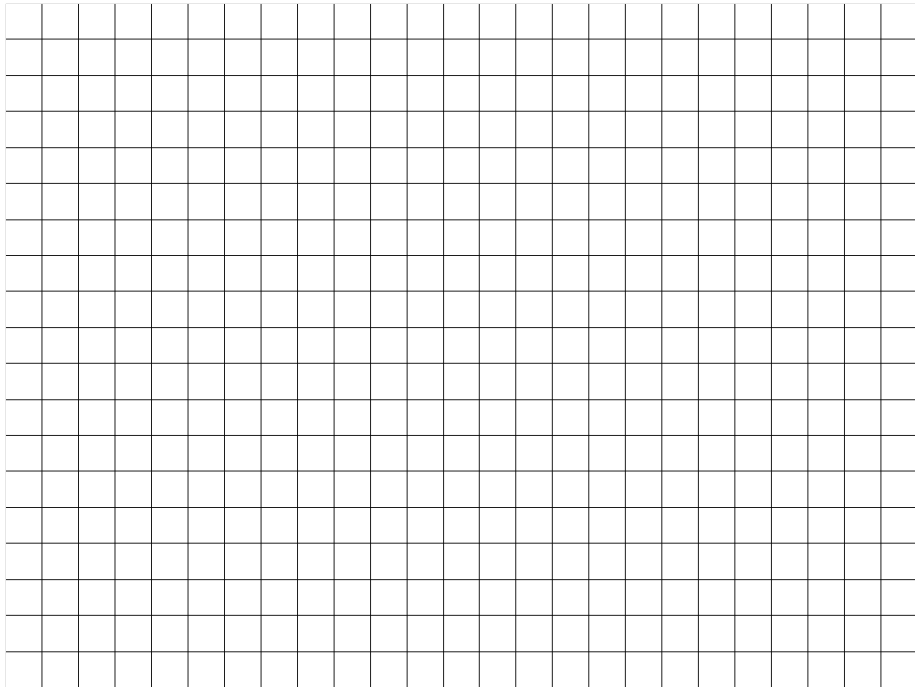

NOTES:

---

---

---

---

---

---

---

---

---

---

Use the above grid to create an illustration of your custom gasket shape. Be sure to include all relevant dimensions. You can also use the notes section to leave any comments or special instructions.



## Other styles of gaskets available from AG:

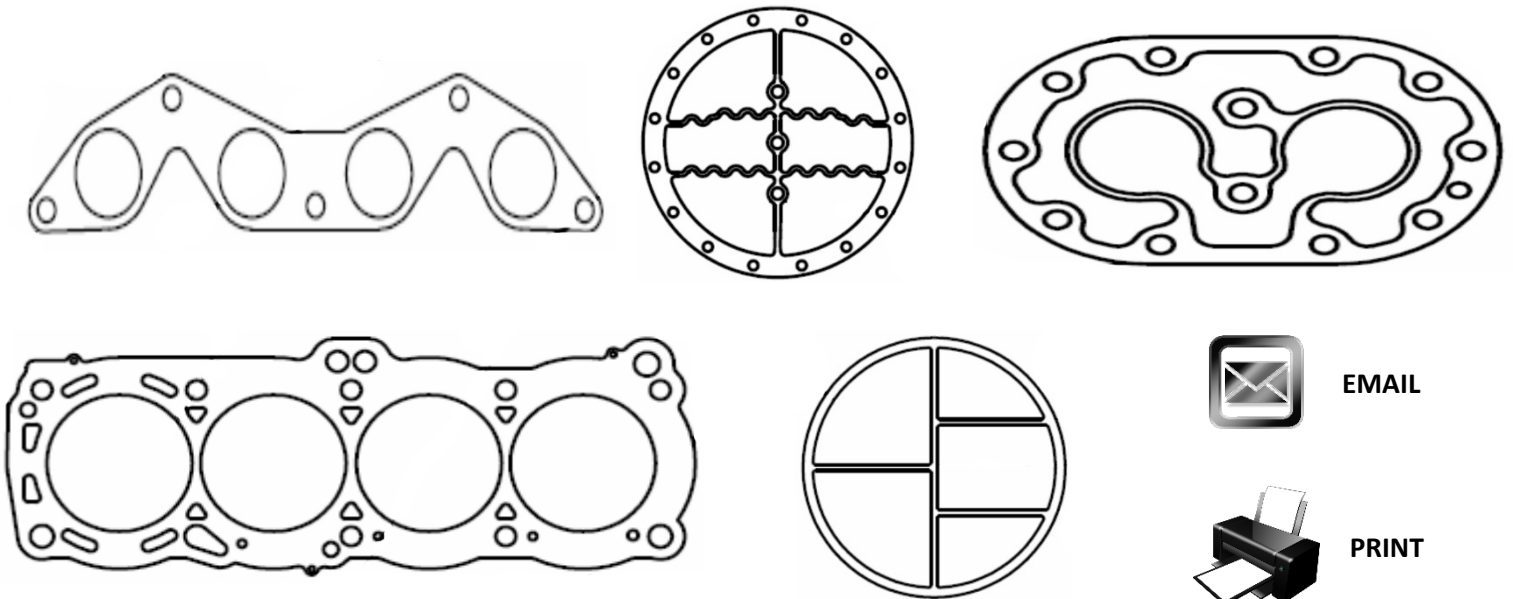

EMAIL



PRINT